

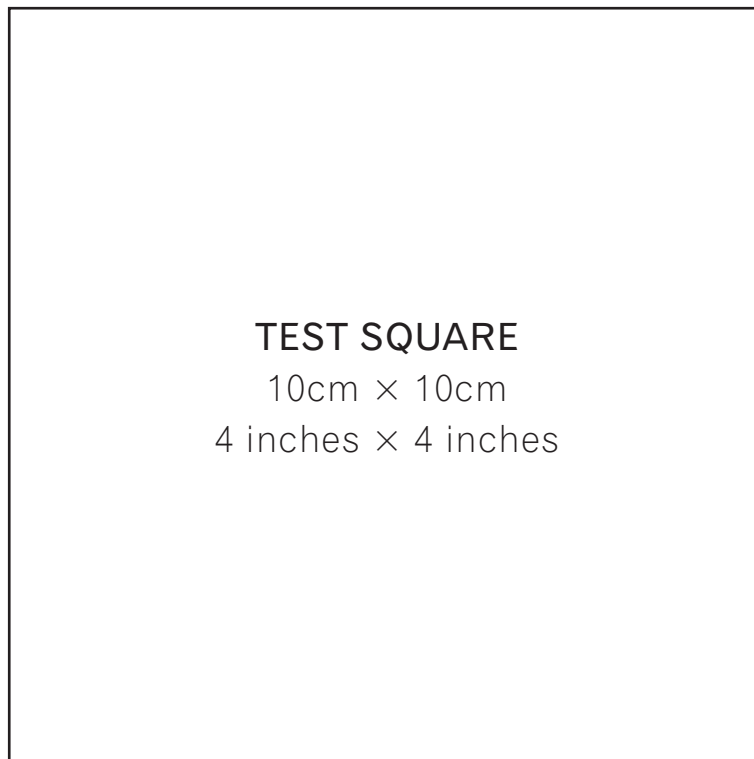

XS \_\_\_\_\_  
S .....  
M - - - - -  
L \_\_\_\_\_  
XL \_\_\_\_\_

**Kimono Jacket**

Project design © Love Productions 2015  
This design is protected by copyright and  
must not be made for resale.



**TEST SQUARE**  
10cm × 10cm  
4 inches × 4 inches

1A

1B

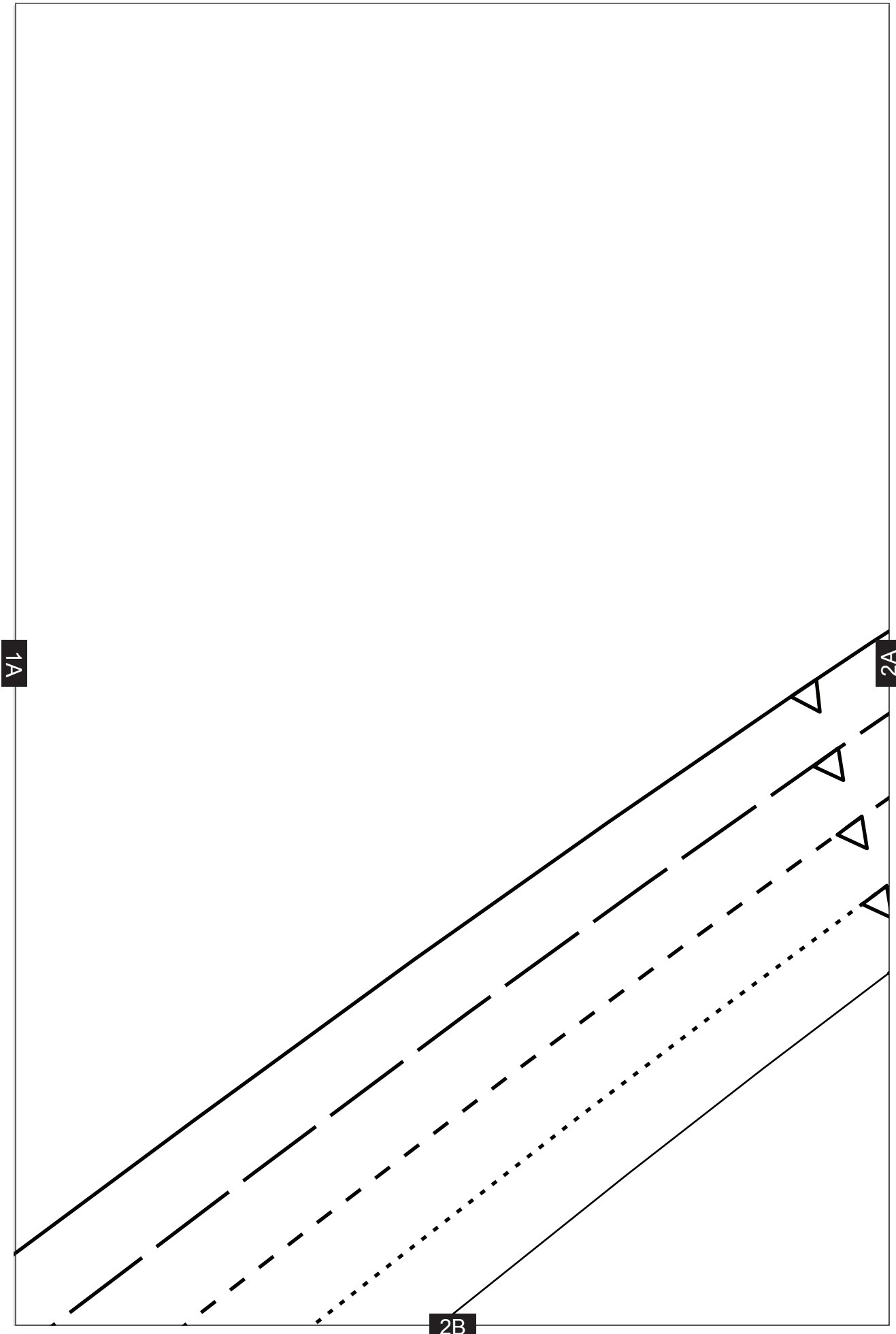

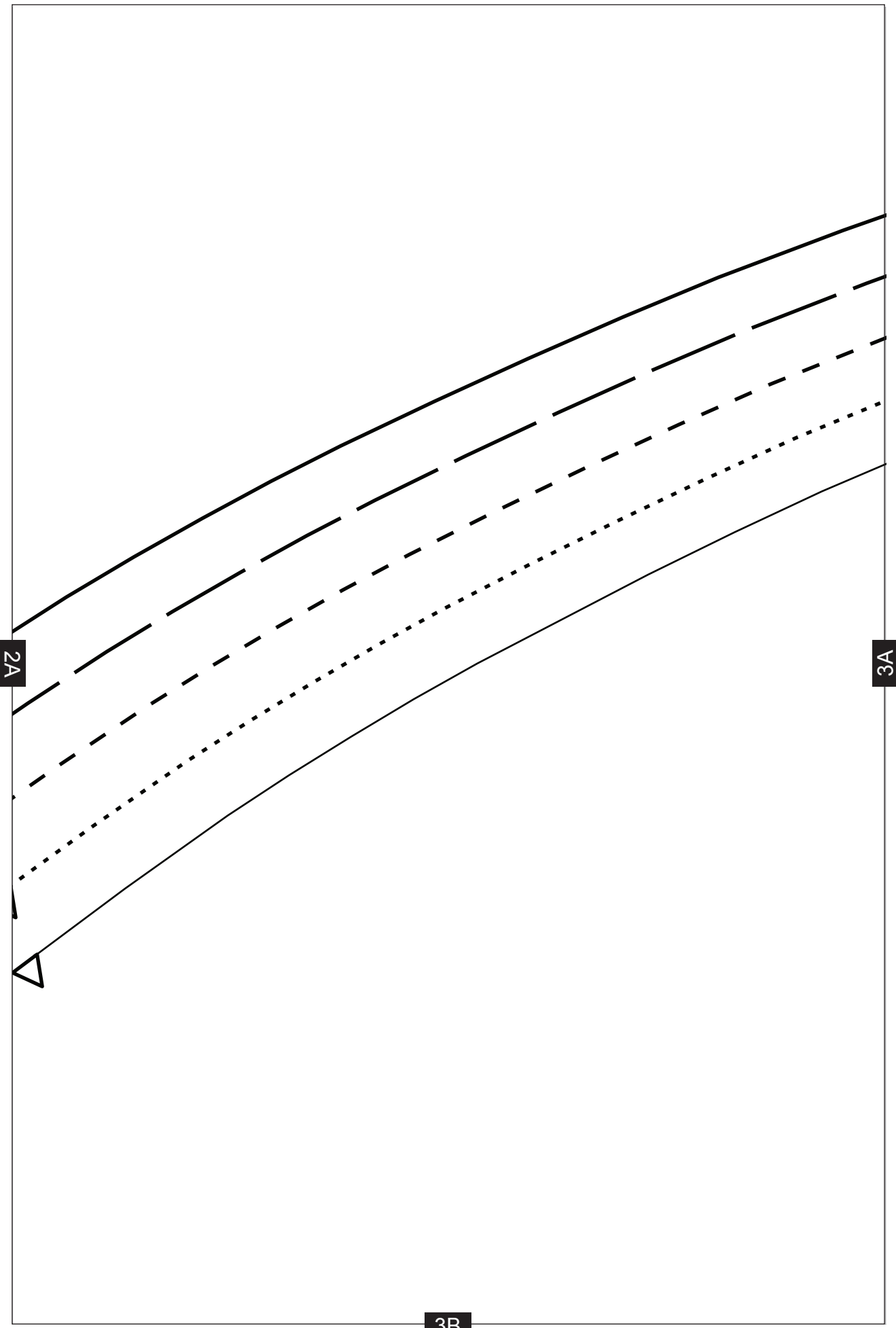

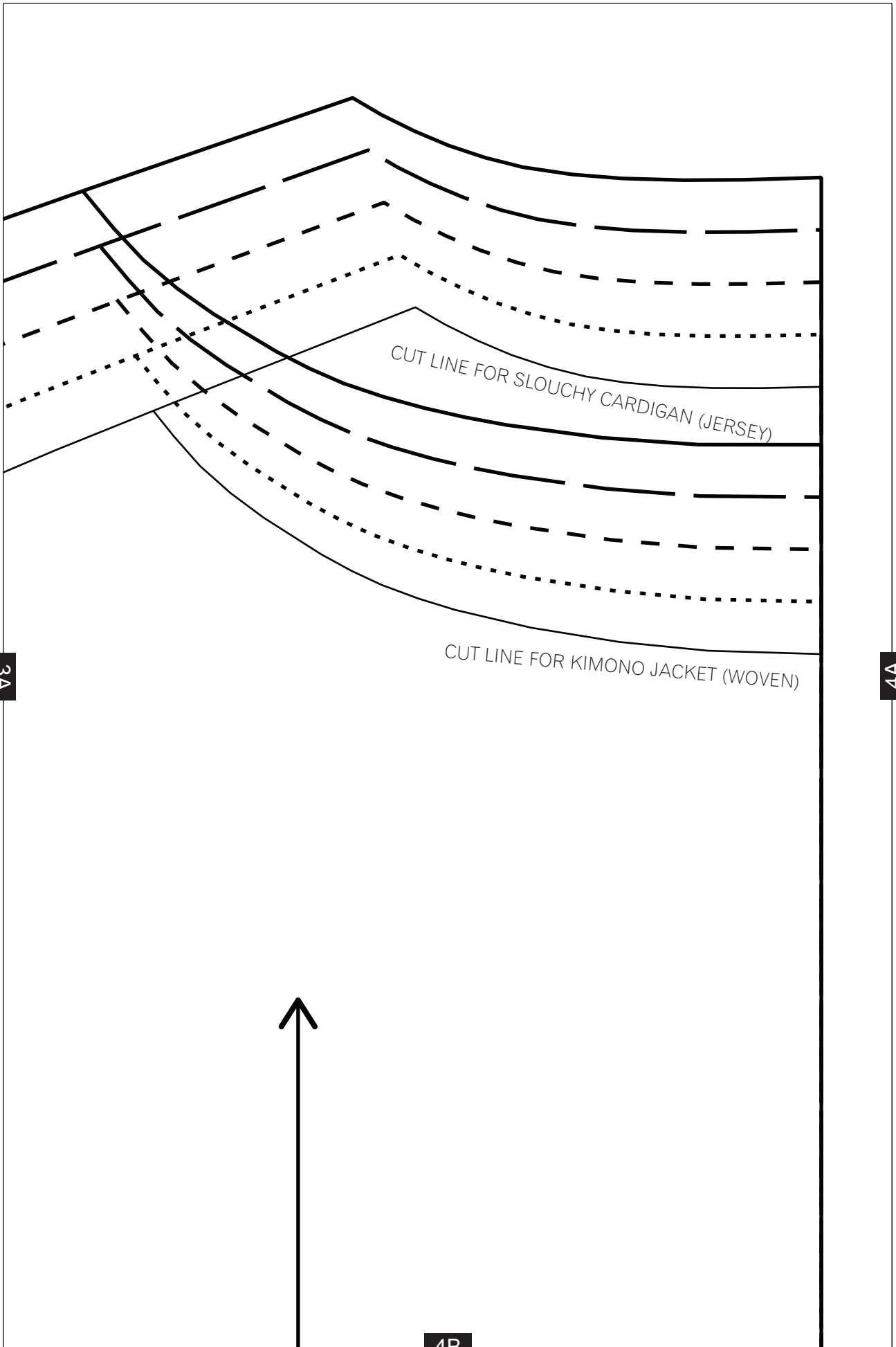

3A

4A

4B

CUT LINE FOR SLOUCHY CARDIGAN (JERSEY)

CUT LINE FOR KIMONO JACKET (WOVEN)

4A

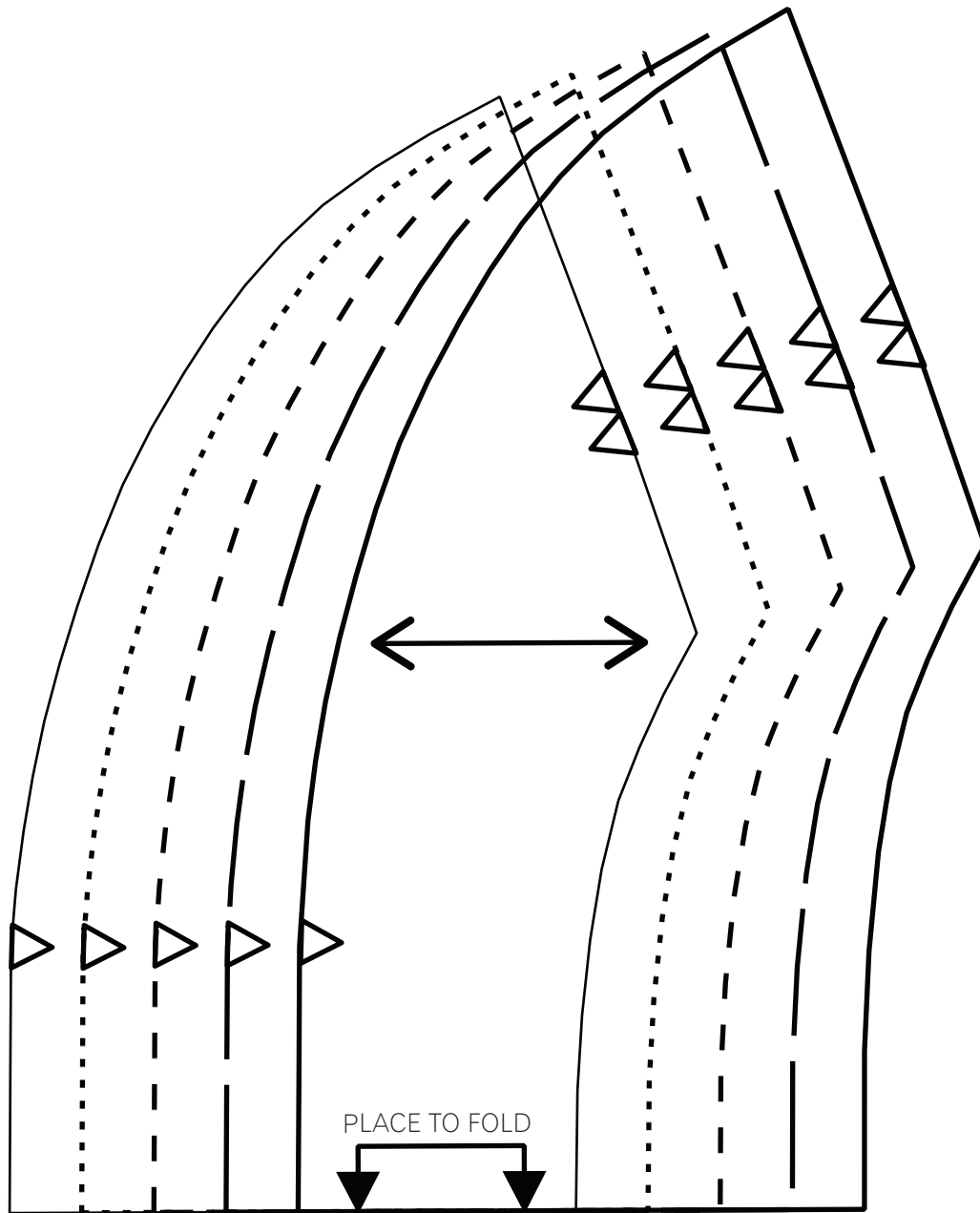

5A

## KIMONO JACKET

BACK NECK BAND - CUT 2 ON FOLD  
IN FABRIC + CUT ON FOLD IN INTERFACING

5B

5A

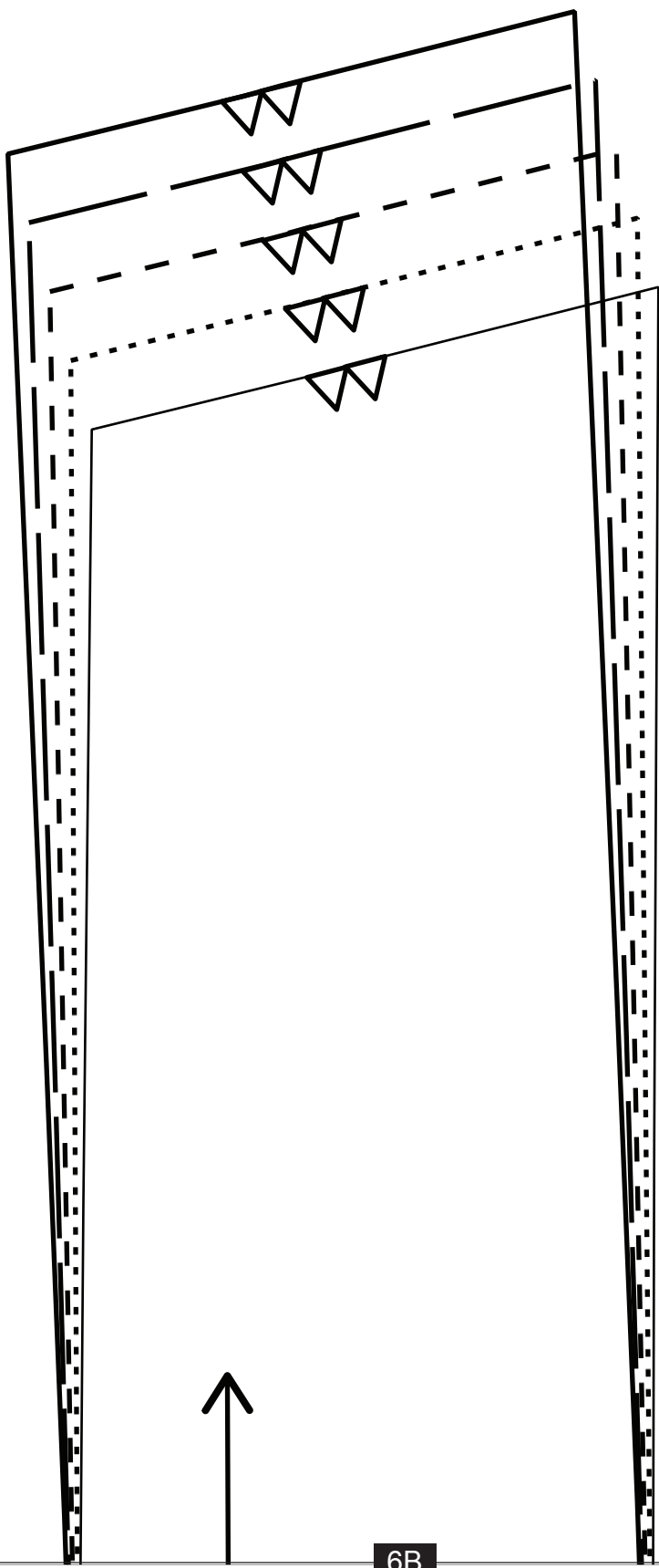

6B

1B

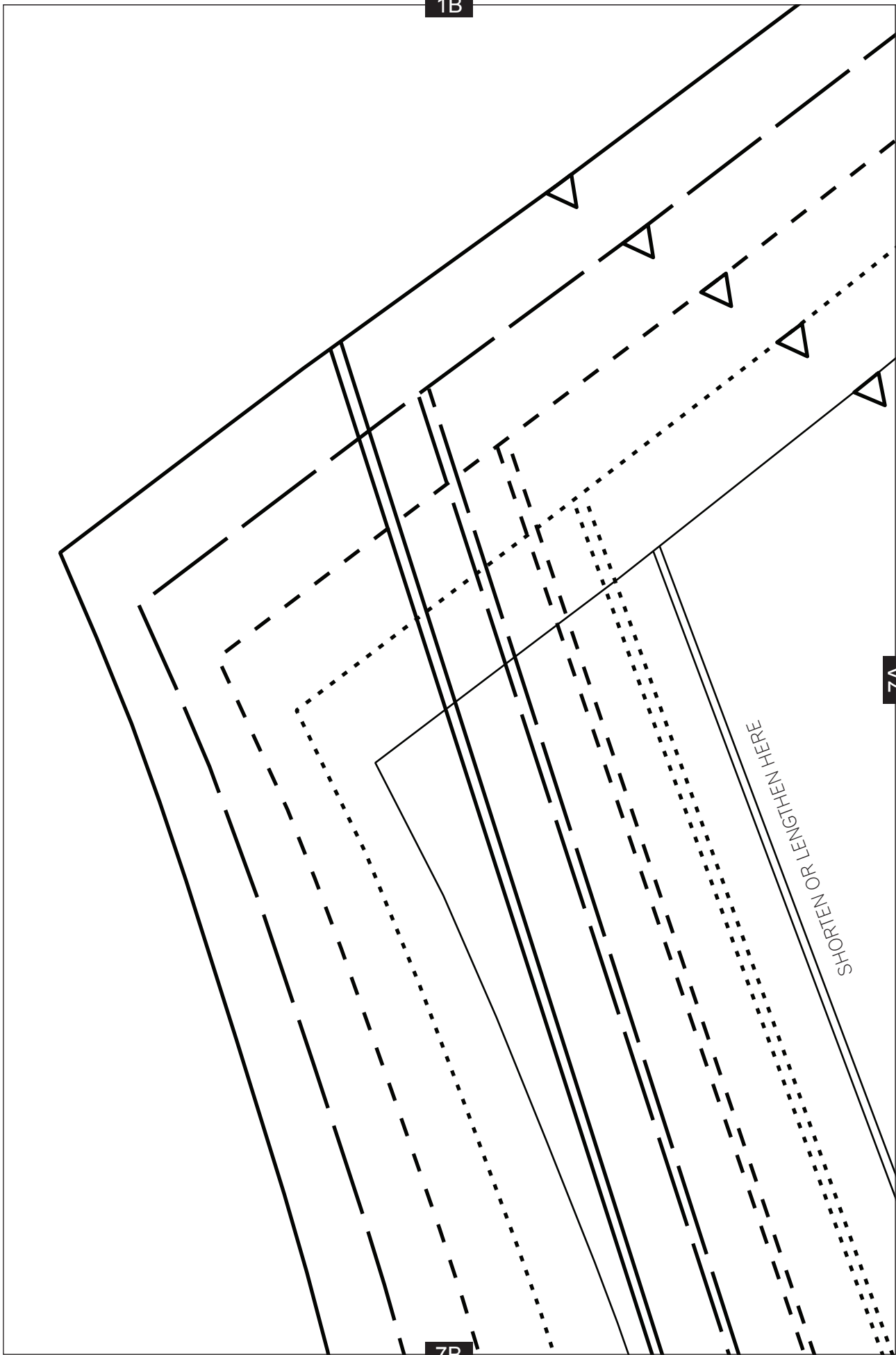

7A

SHORTEN OR LENGTHEN HERE

7B

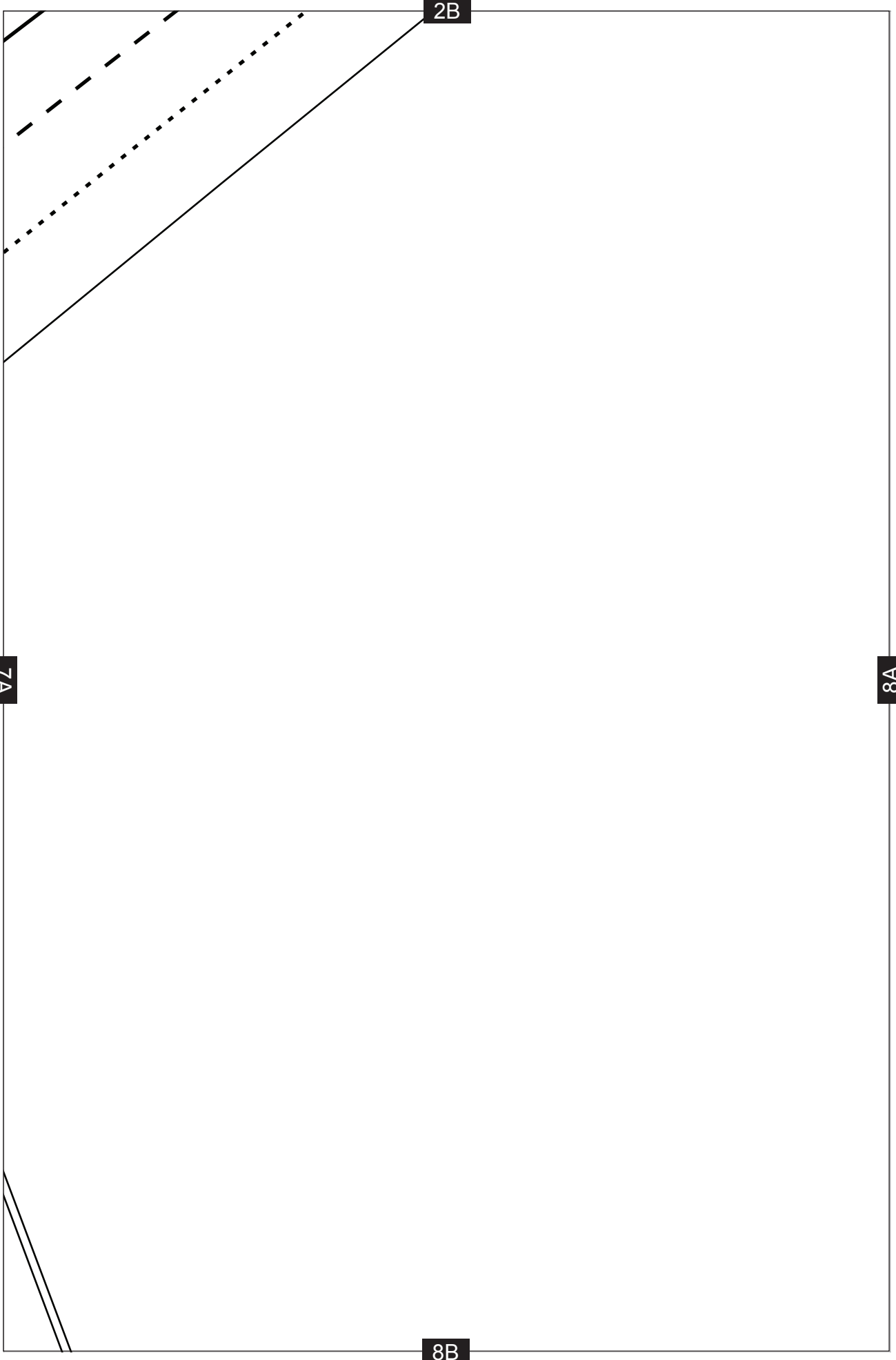



3B

**KIMONO JACKET**  
BACK – CUT ON FOLD

8A

9A

9B

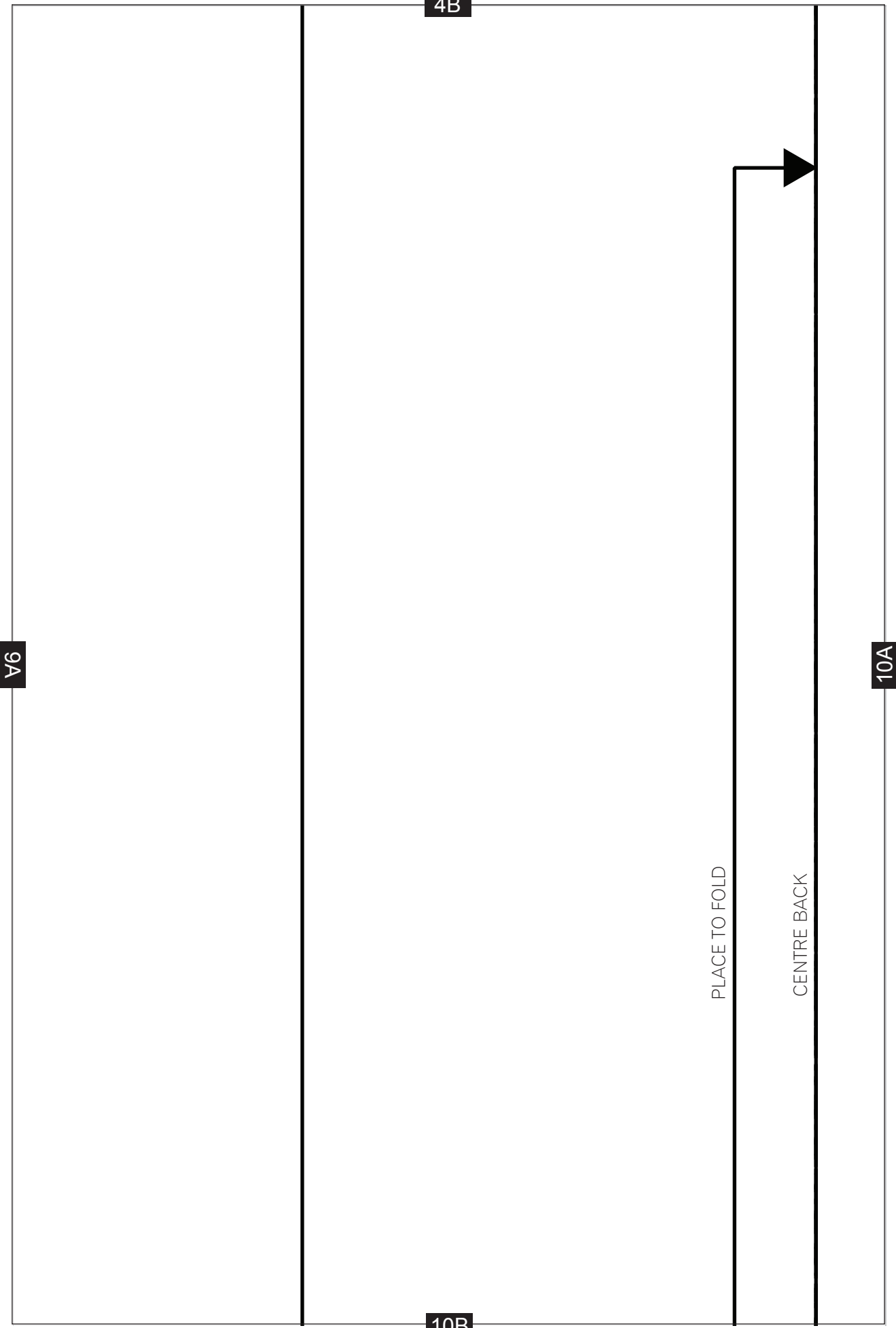

9A

4B

10A

10B

PLACE TO FOLD

CENTRE BACK

5B

10A

11A

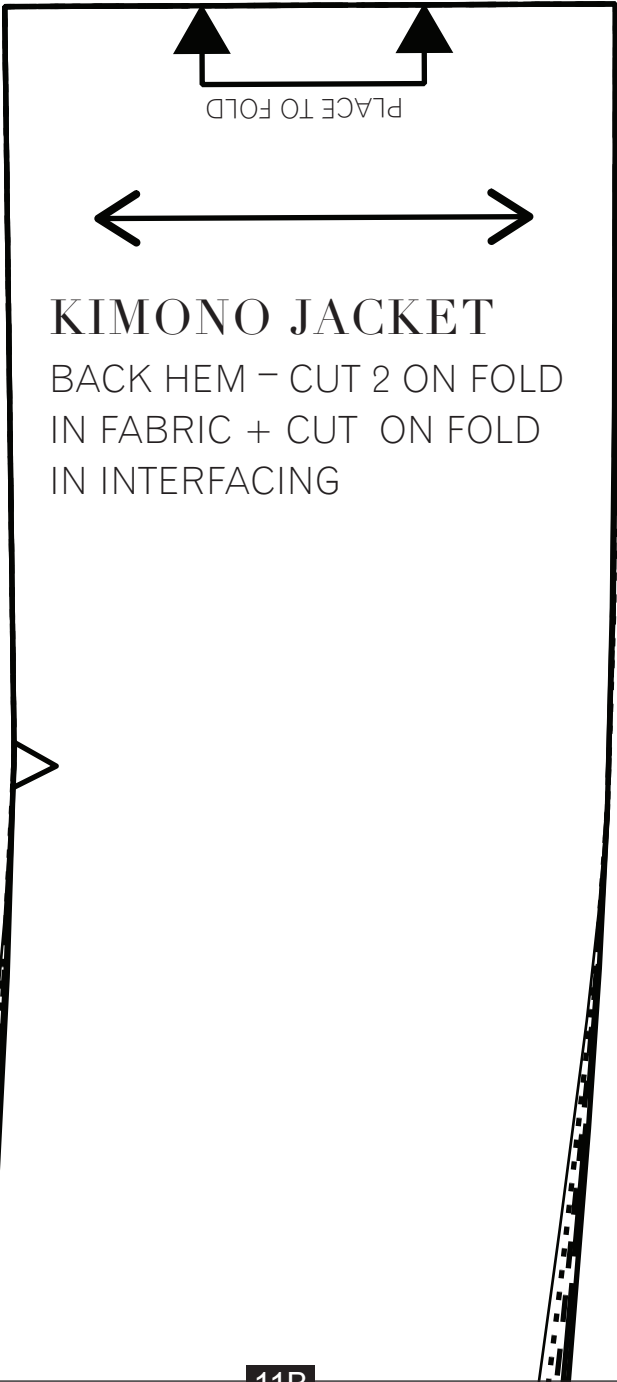

11B

6B

11A

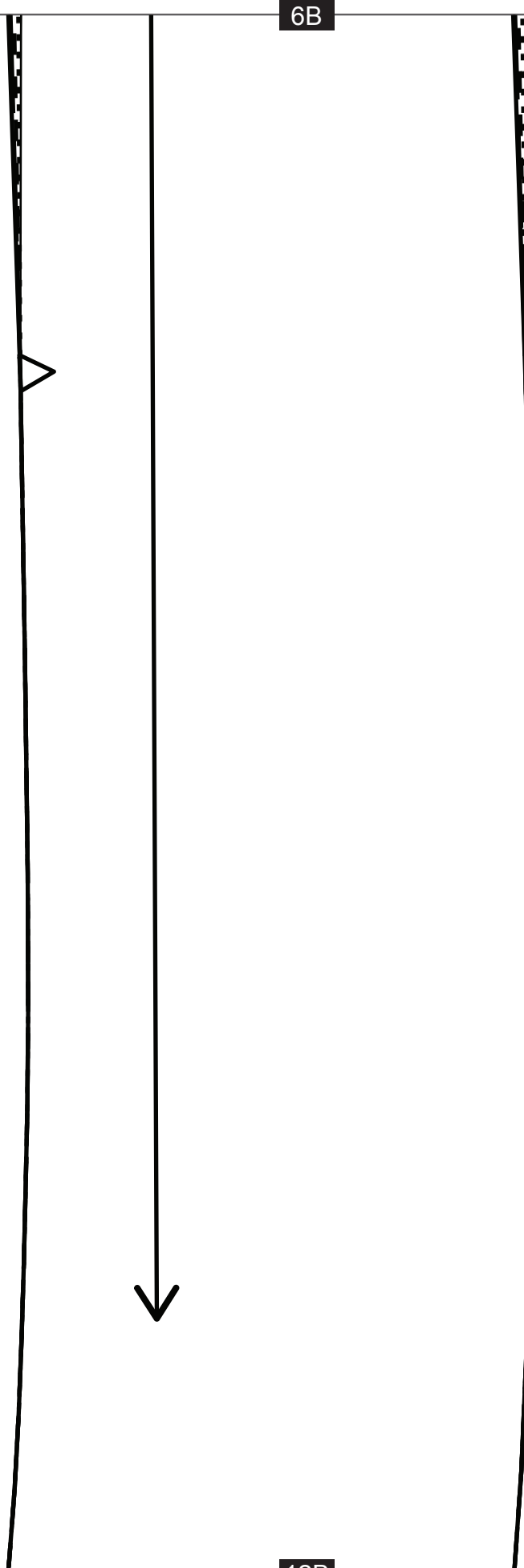

12B

7B

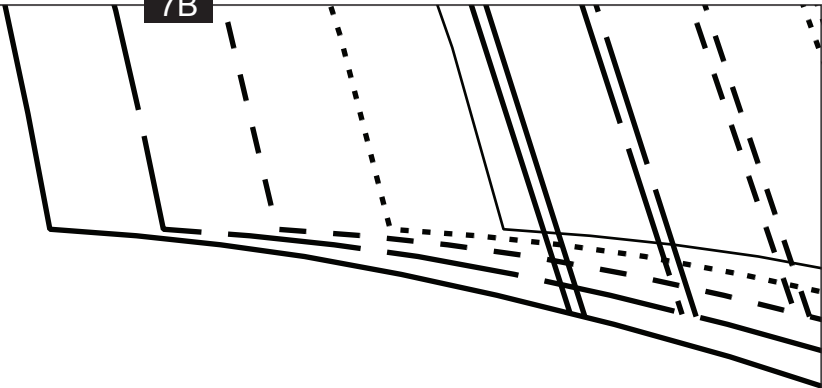

13A

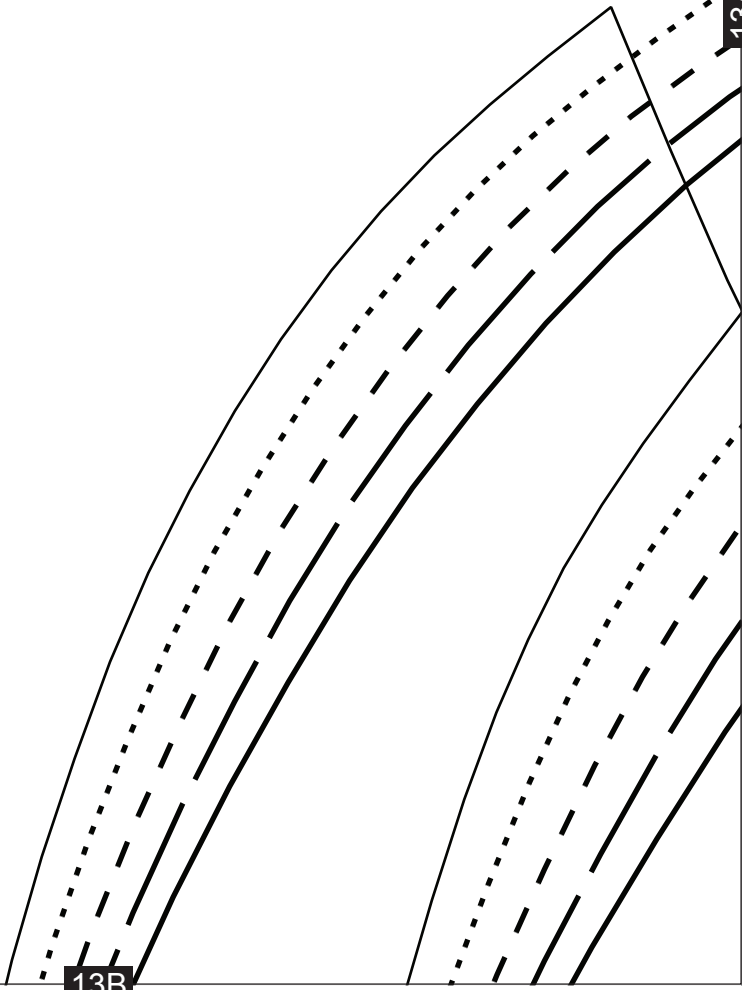

13B

8B

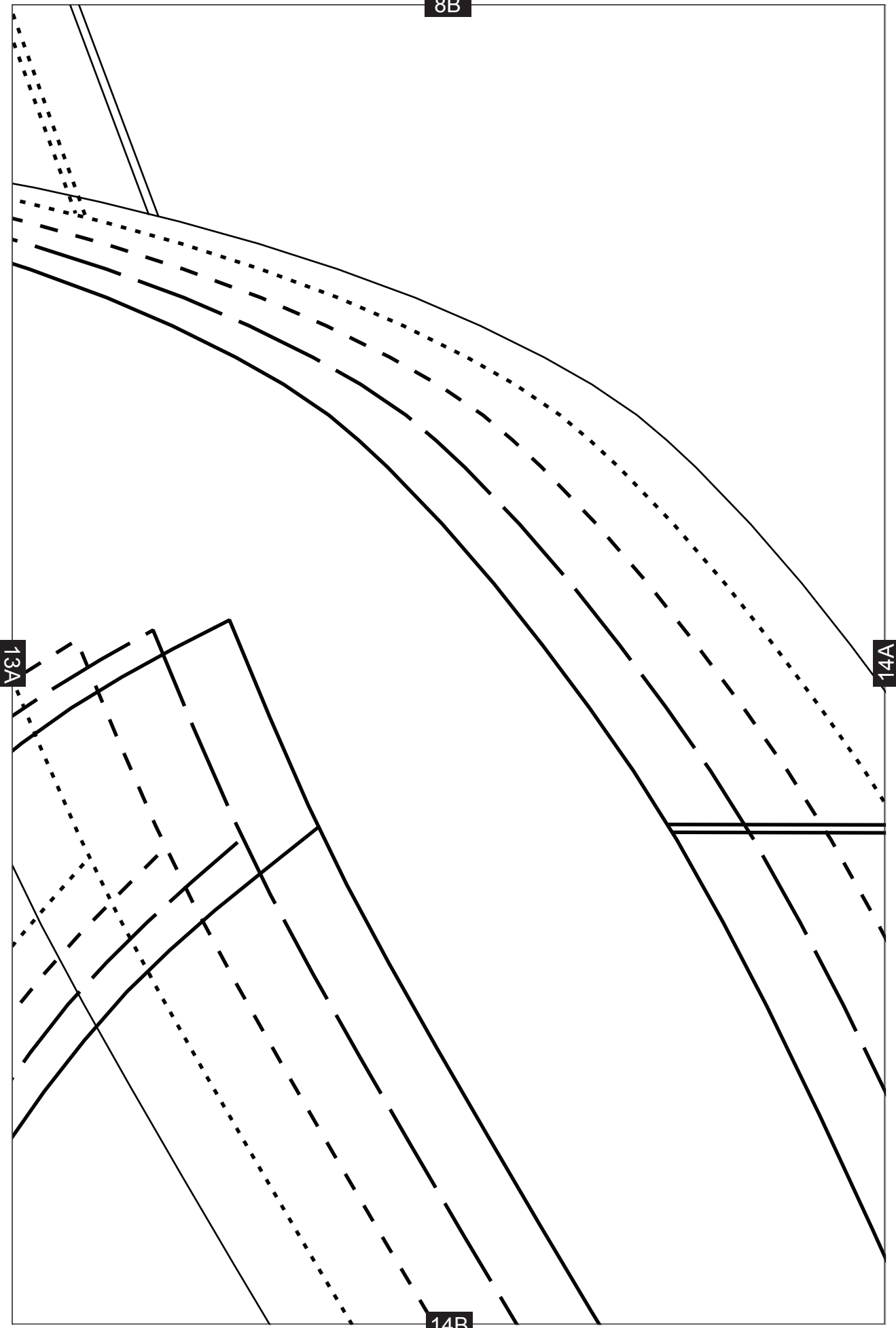

13A

14A

14B

9B

14A

15A

15B

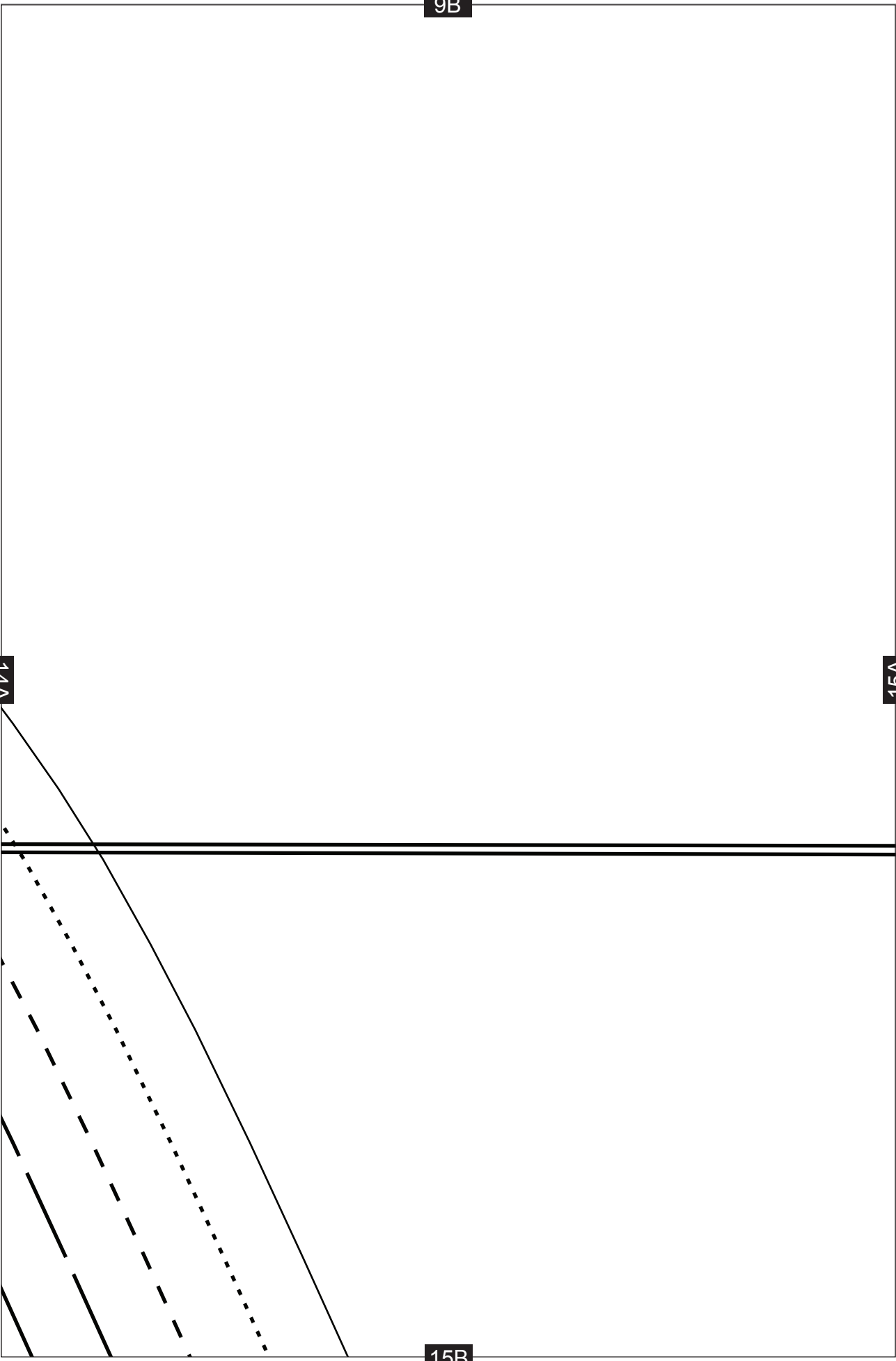

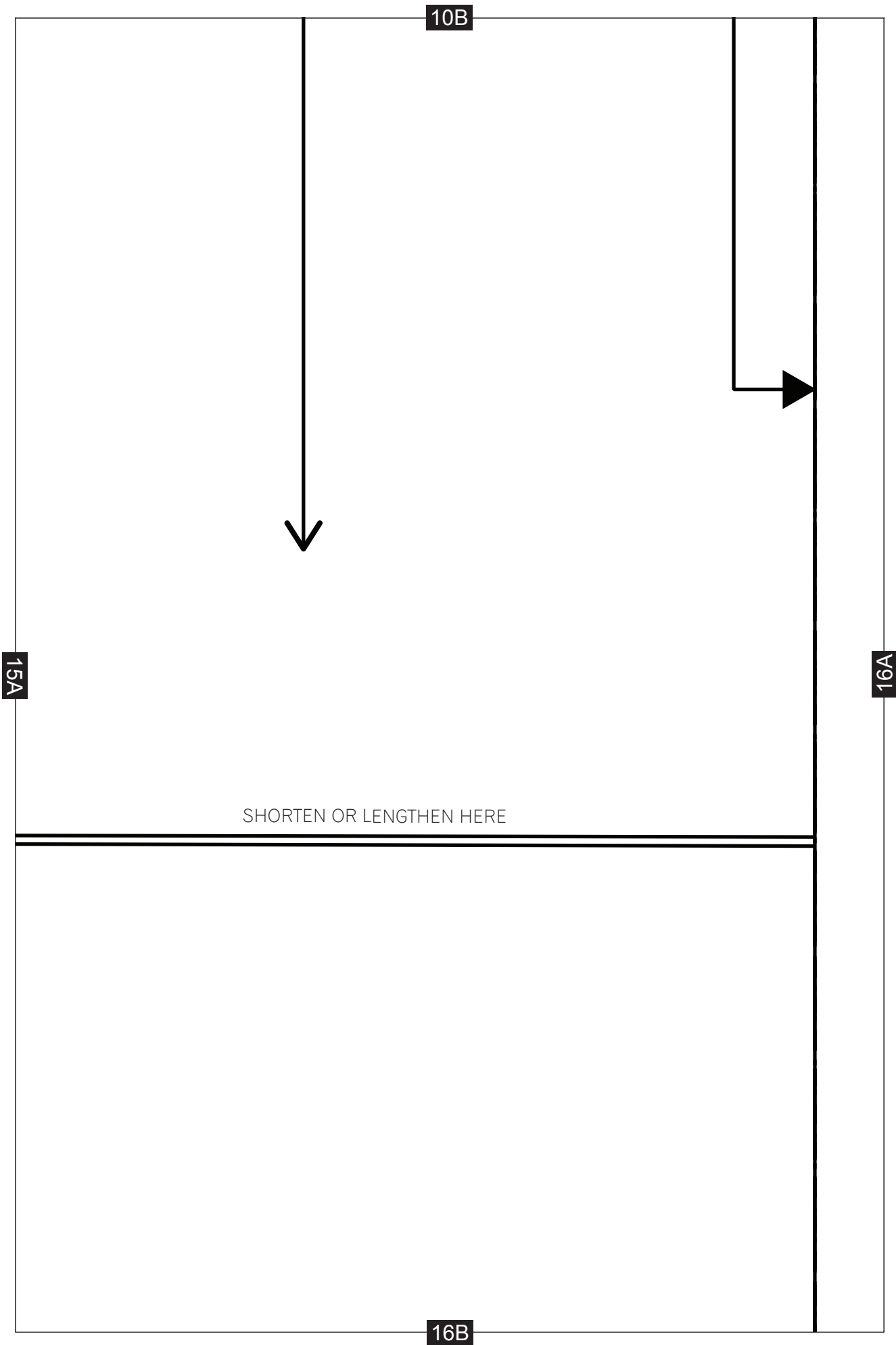



11B

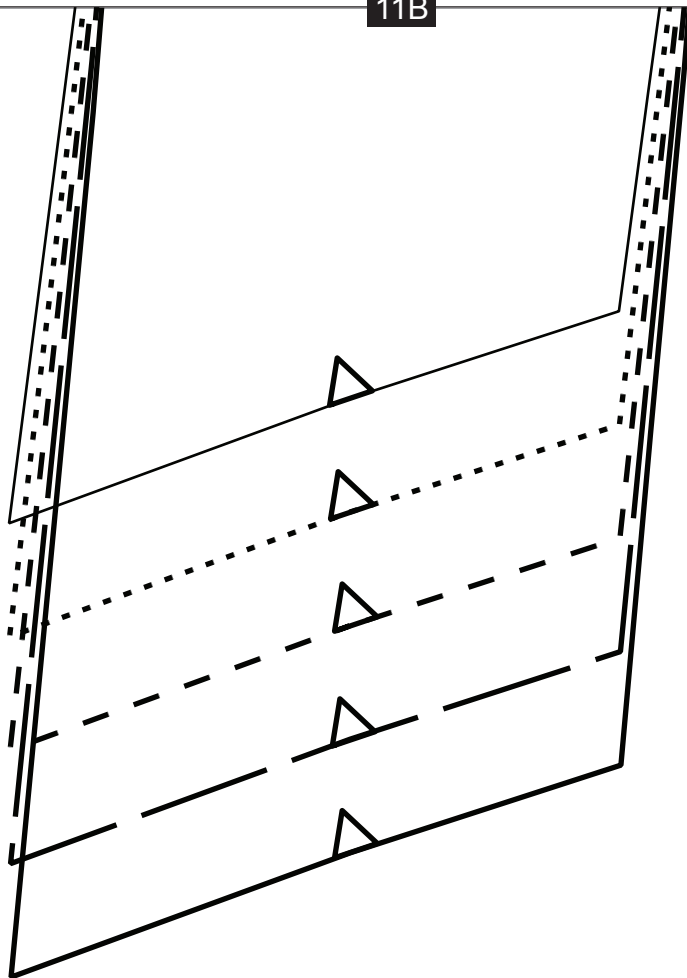

16A

17A

17B

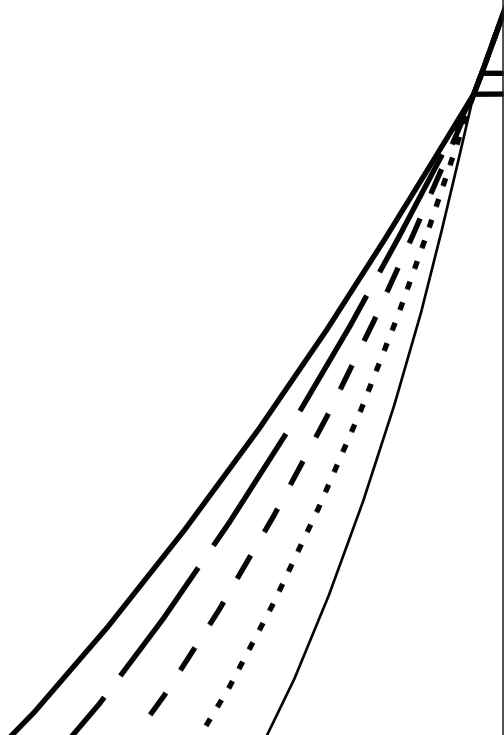

12B

# KIMONO JACKET

FRONT BAND - CUT 2  
PAIRS IN FABRIC + CUT  
PAIR IN INTERFACING

17A

SHORTEN OR LENGTHEN HERE

18B

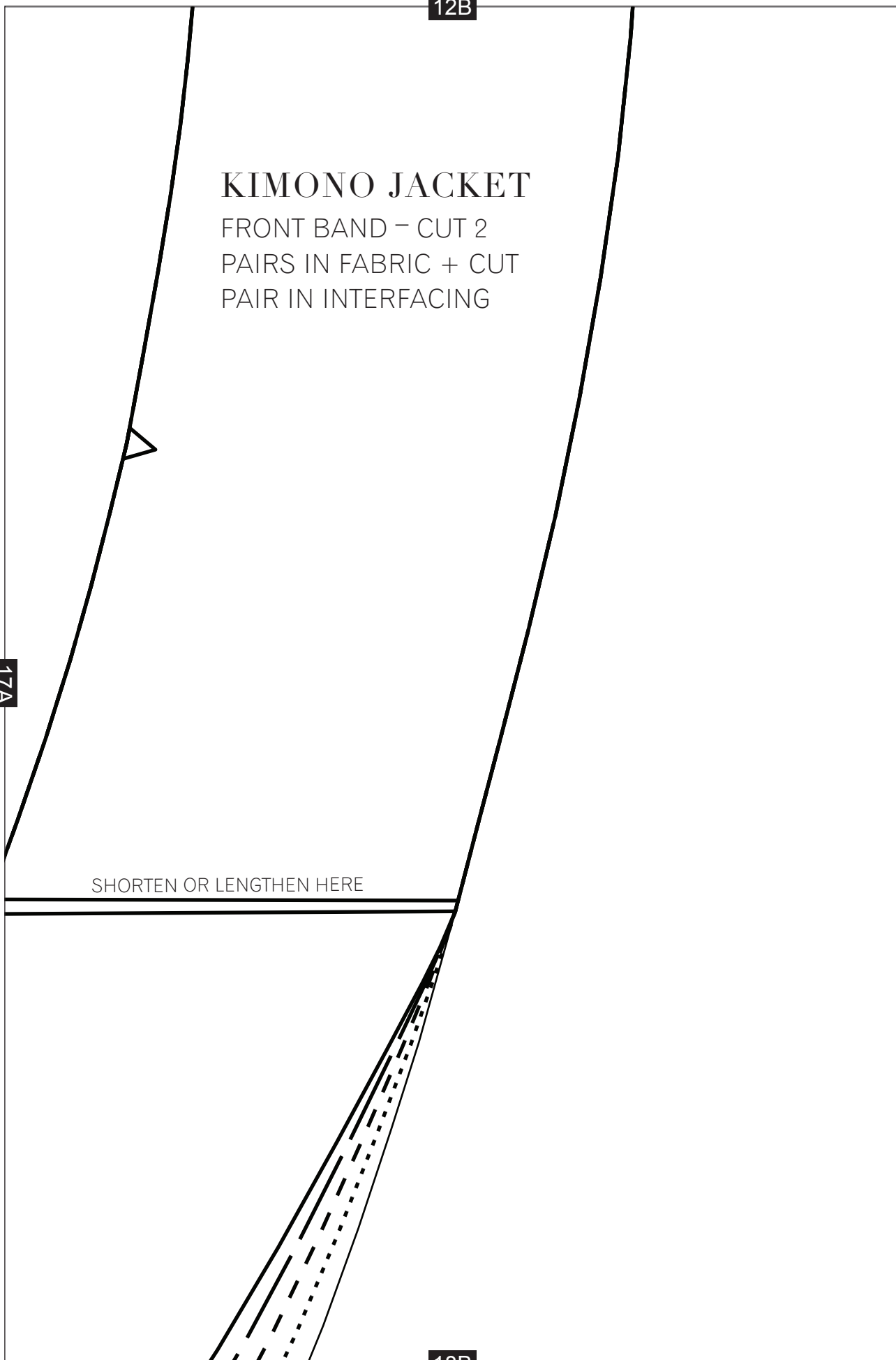

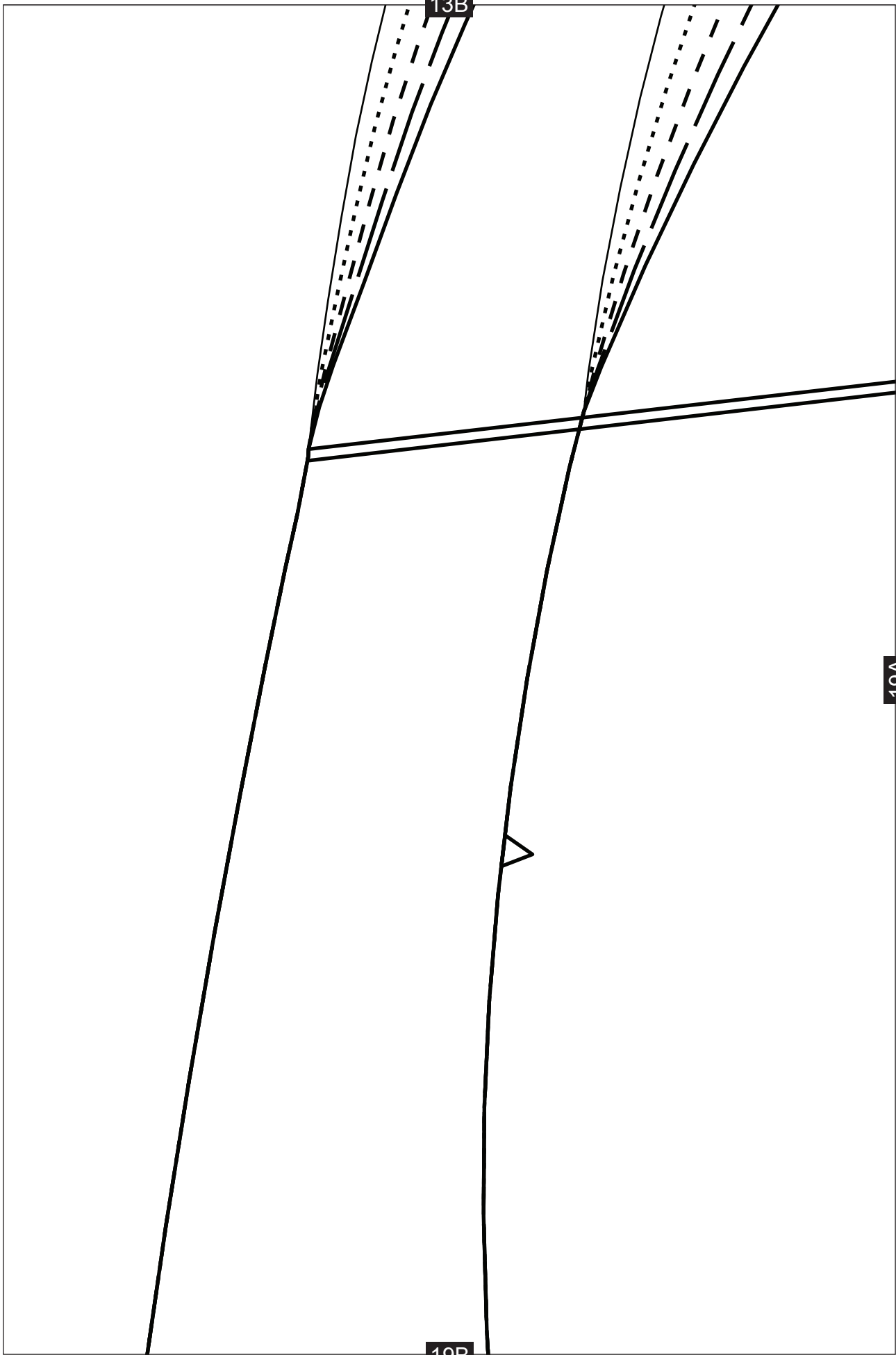

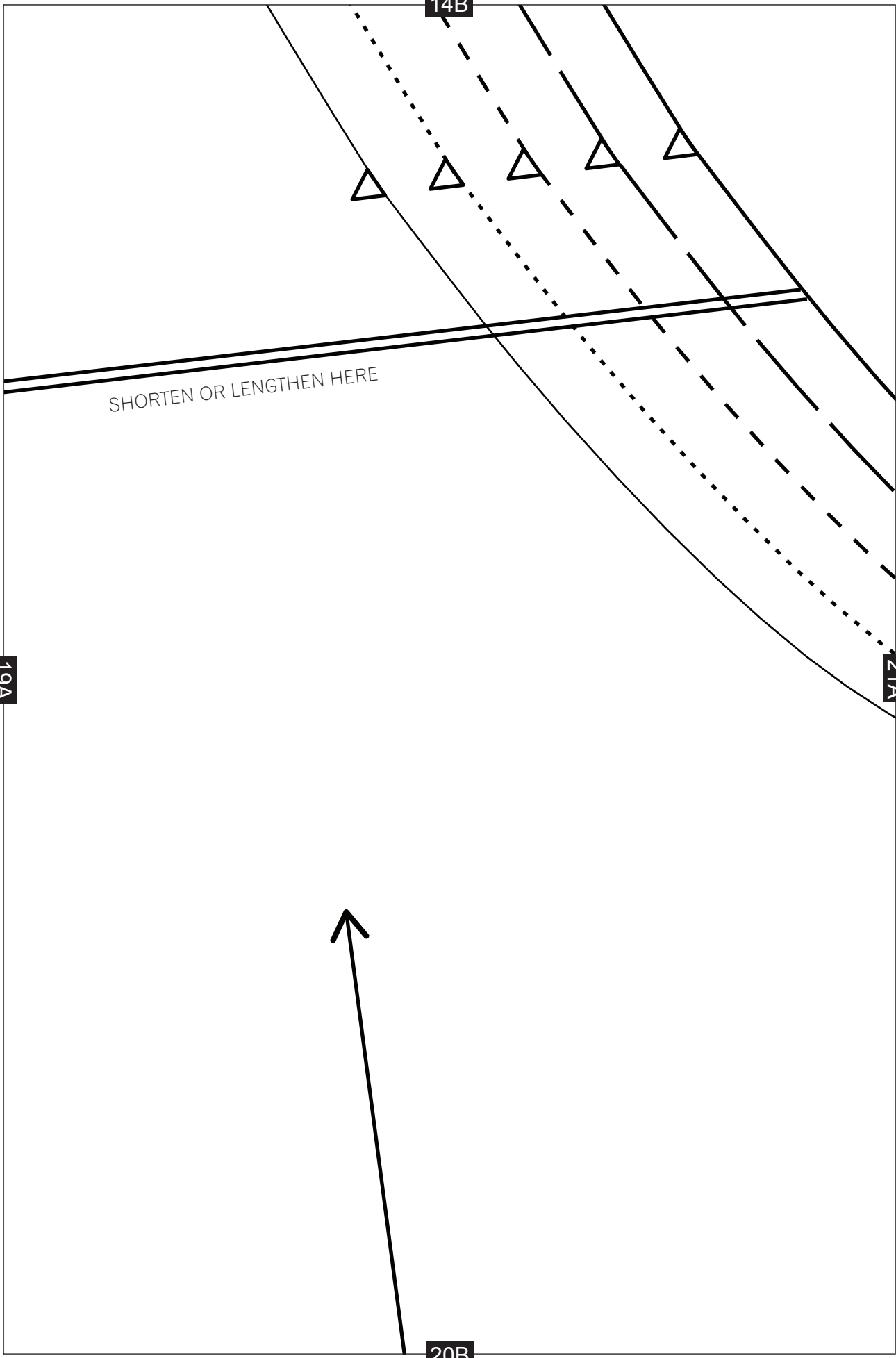

15B

21A

21A

21B

SHORTEN OR LENGTHEN HERE

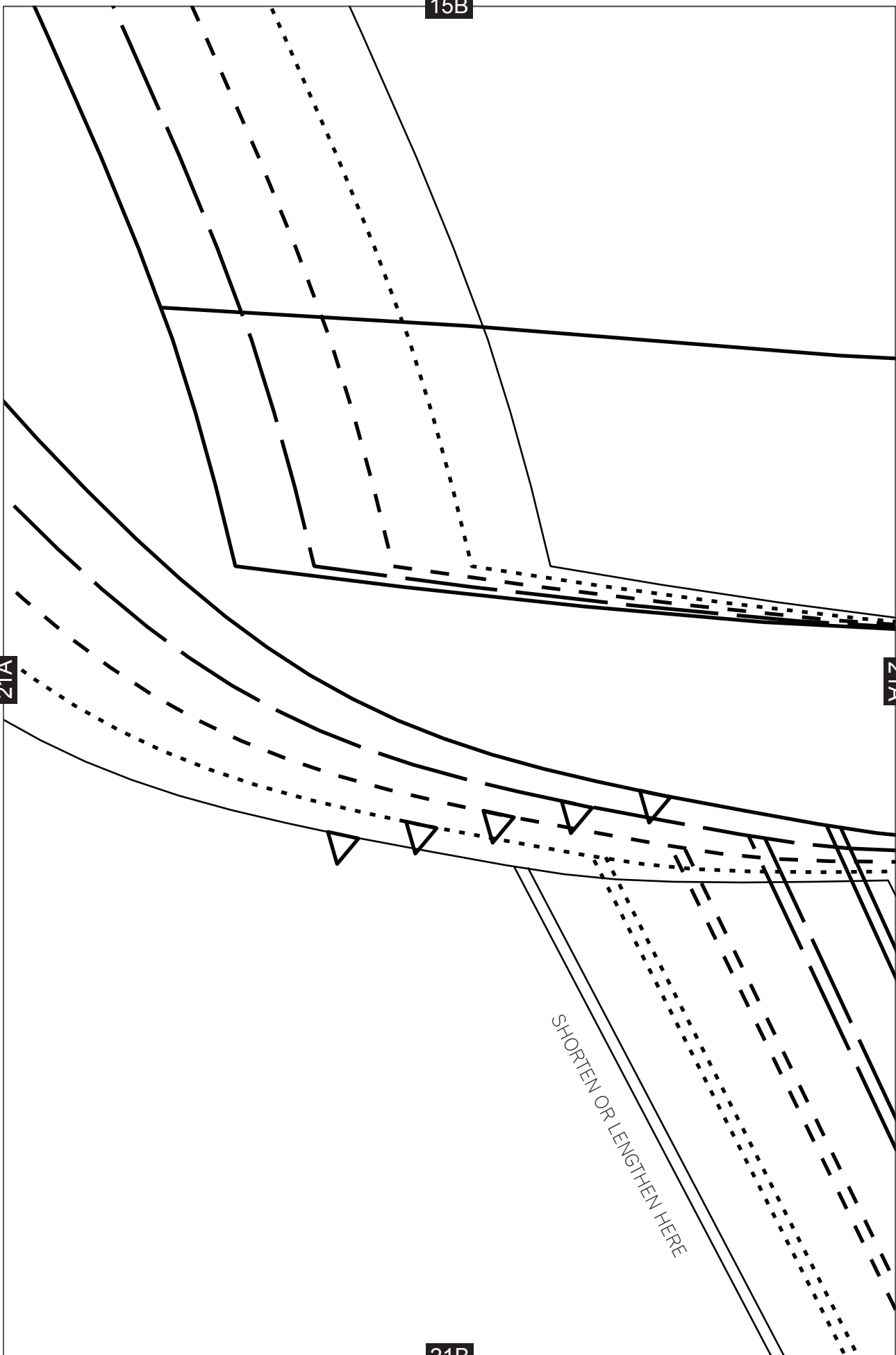

16B

CUT LINE FOR KIMONO JACKET (WOVEN)

CUT LINE FOR SLOUCHY CARDIGAN (JERSEY)

21A

22A

22B

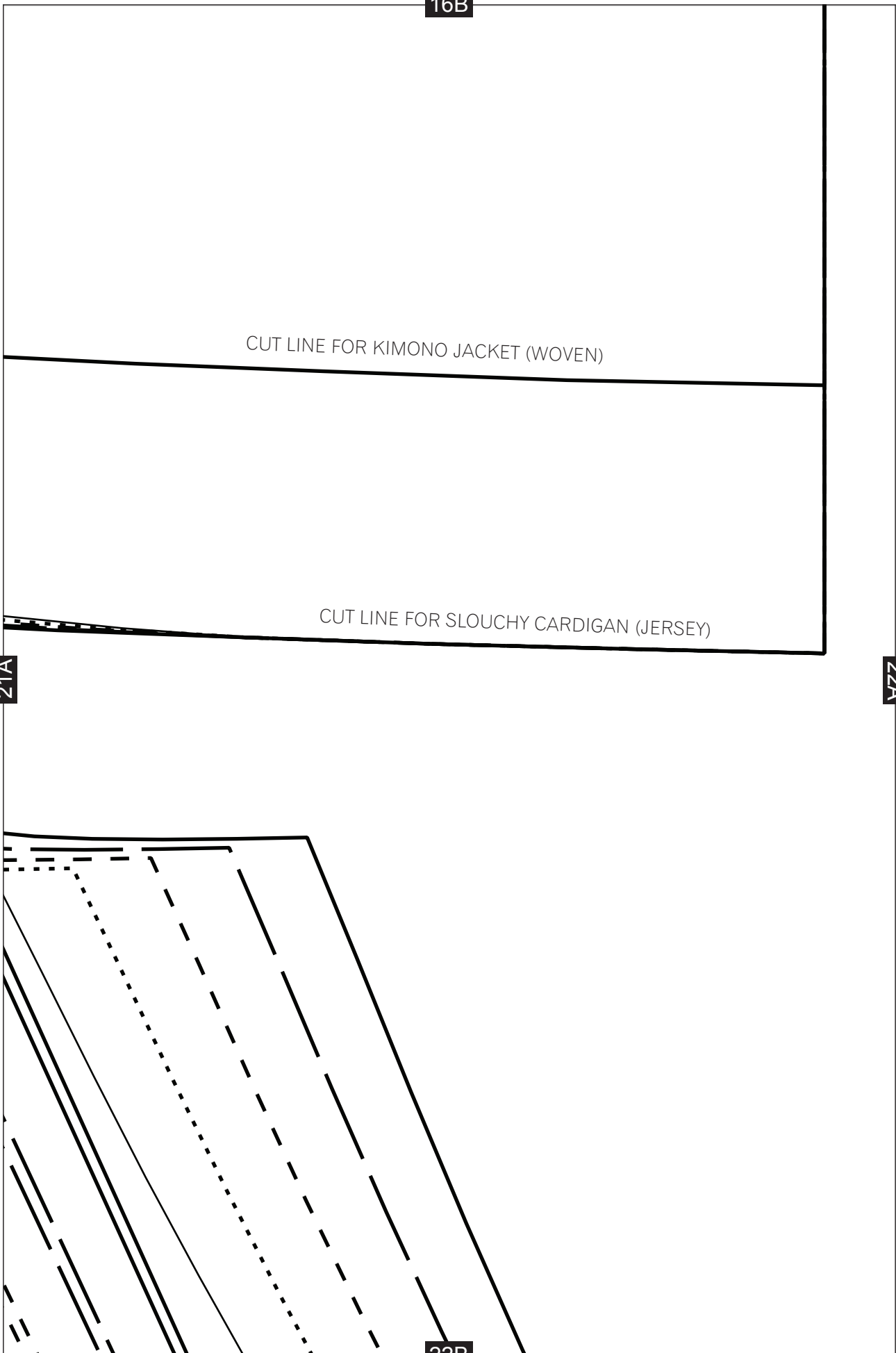

17B

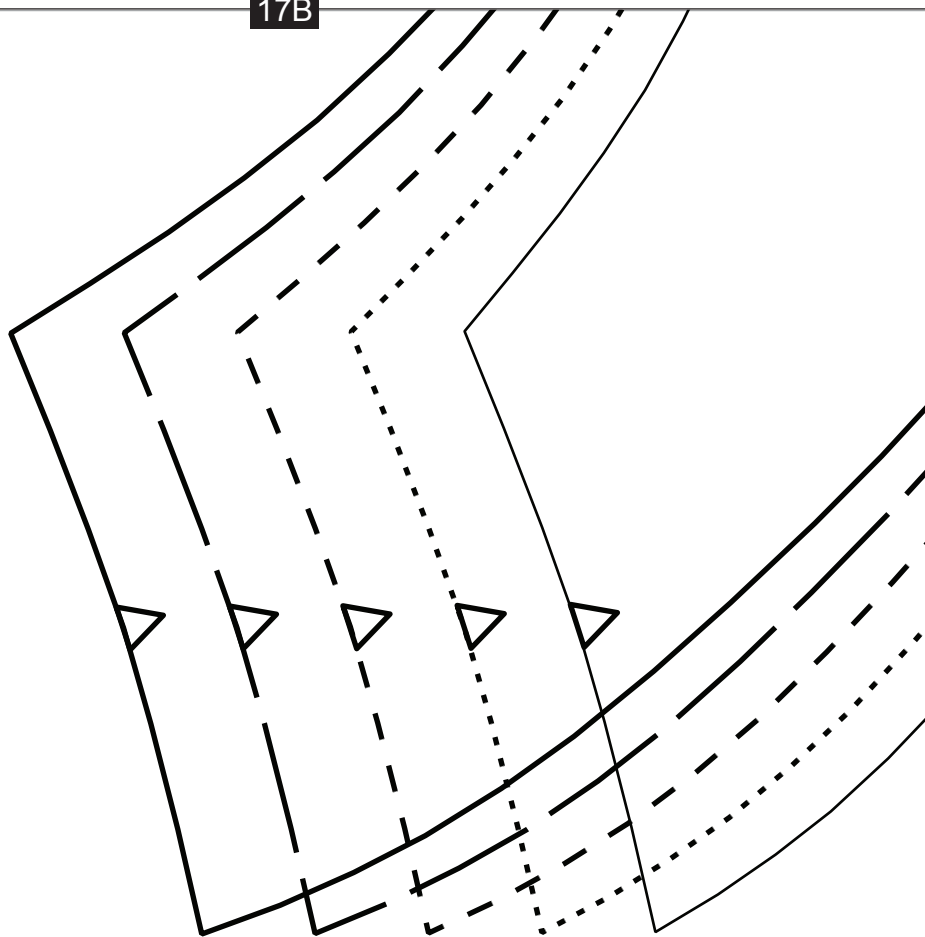

22A

23A

23B

18B

23A

24B

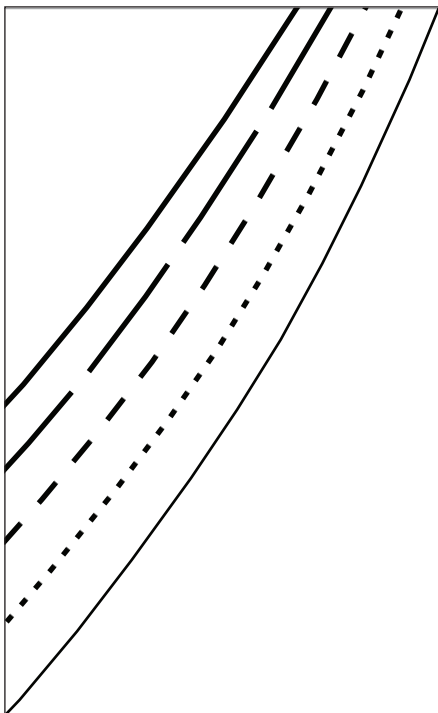



19B

25A

CUT LINE FOR KIMONO JACKET (WOVEN)

25B

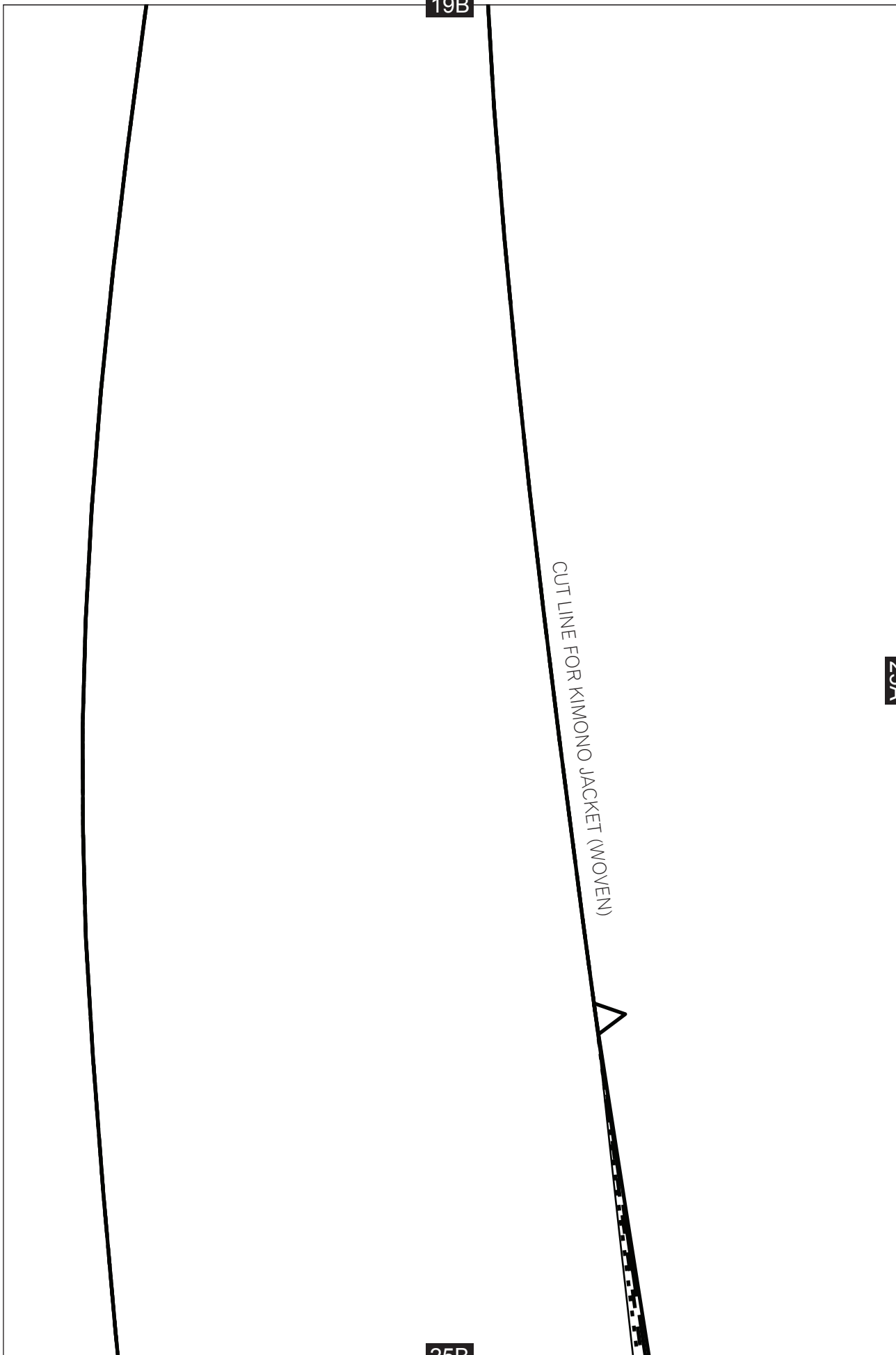

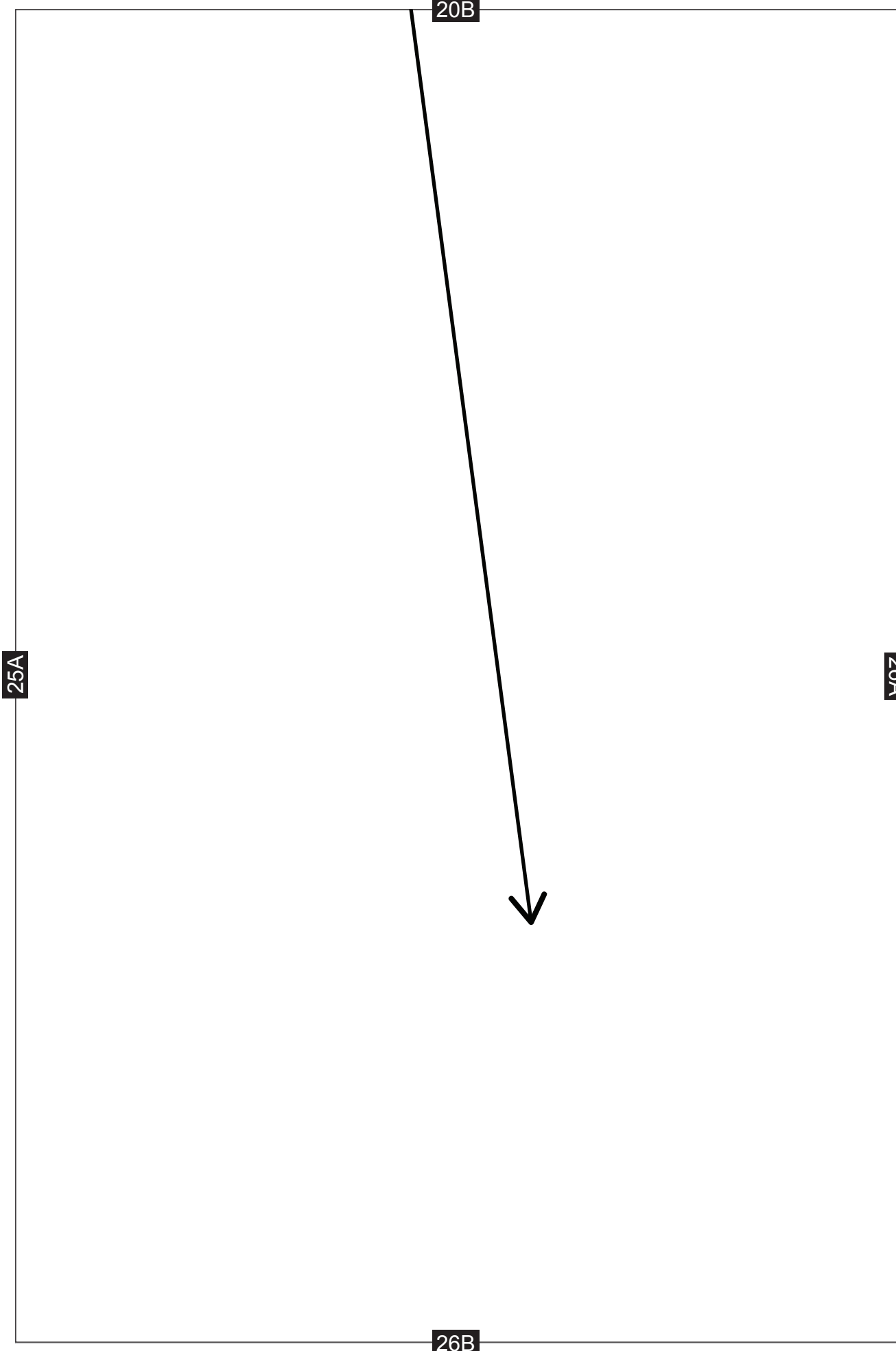

21B

# KIMONO JACKET

FRONT - CUT 2

26A

27A

27B

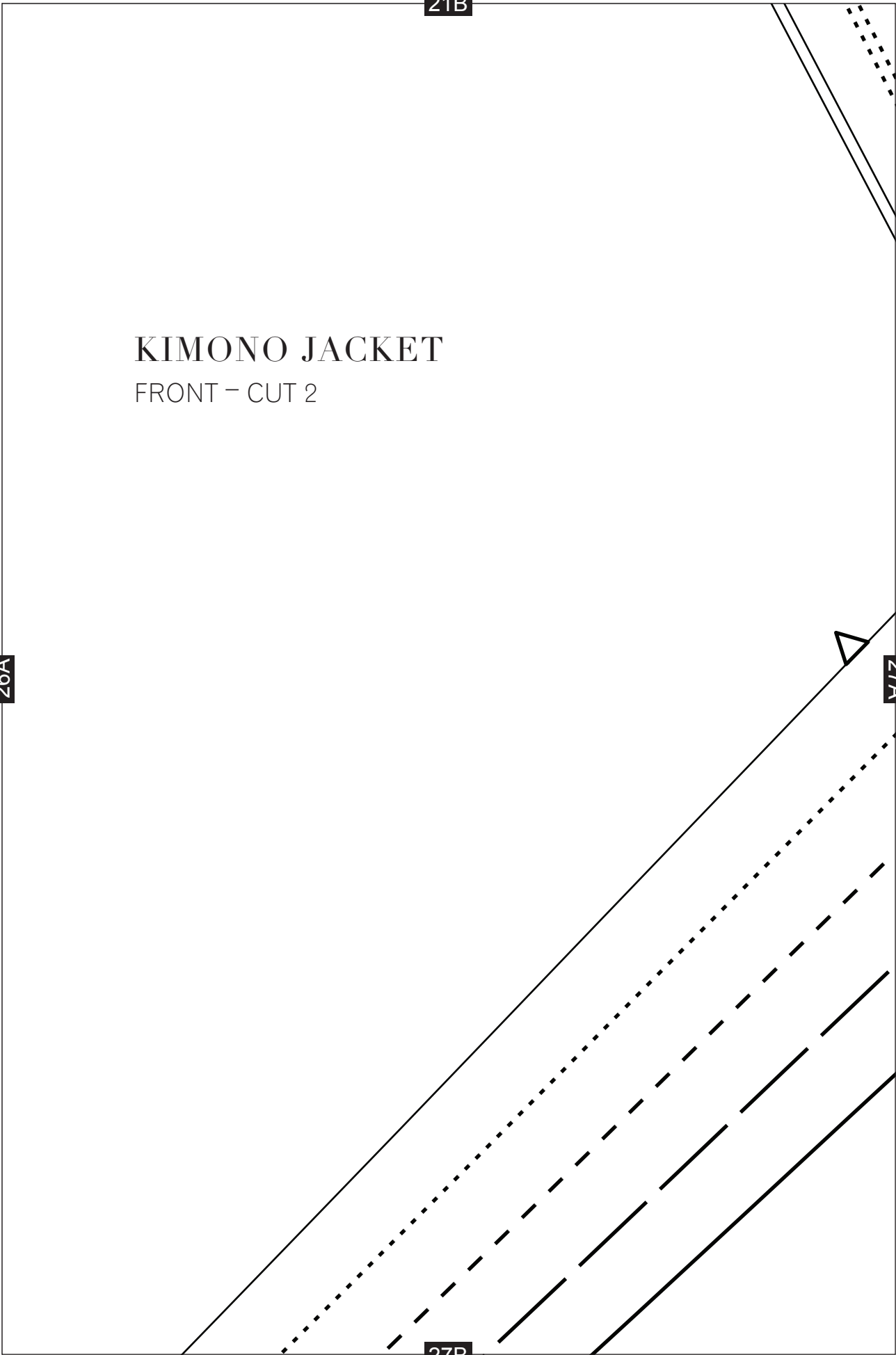

22B

27A

28B

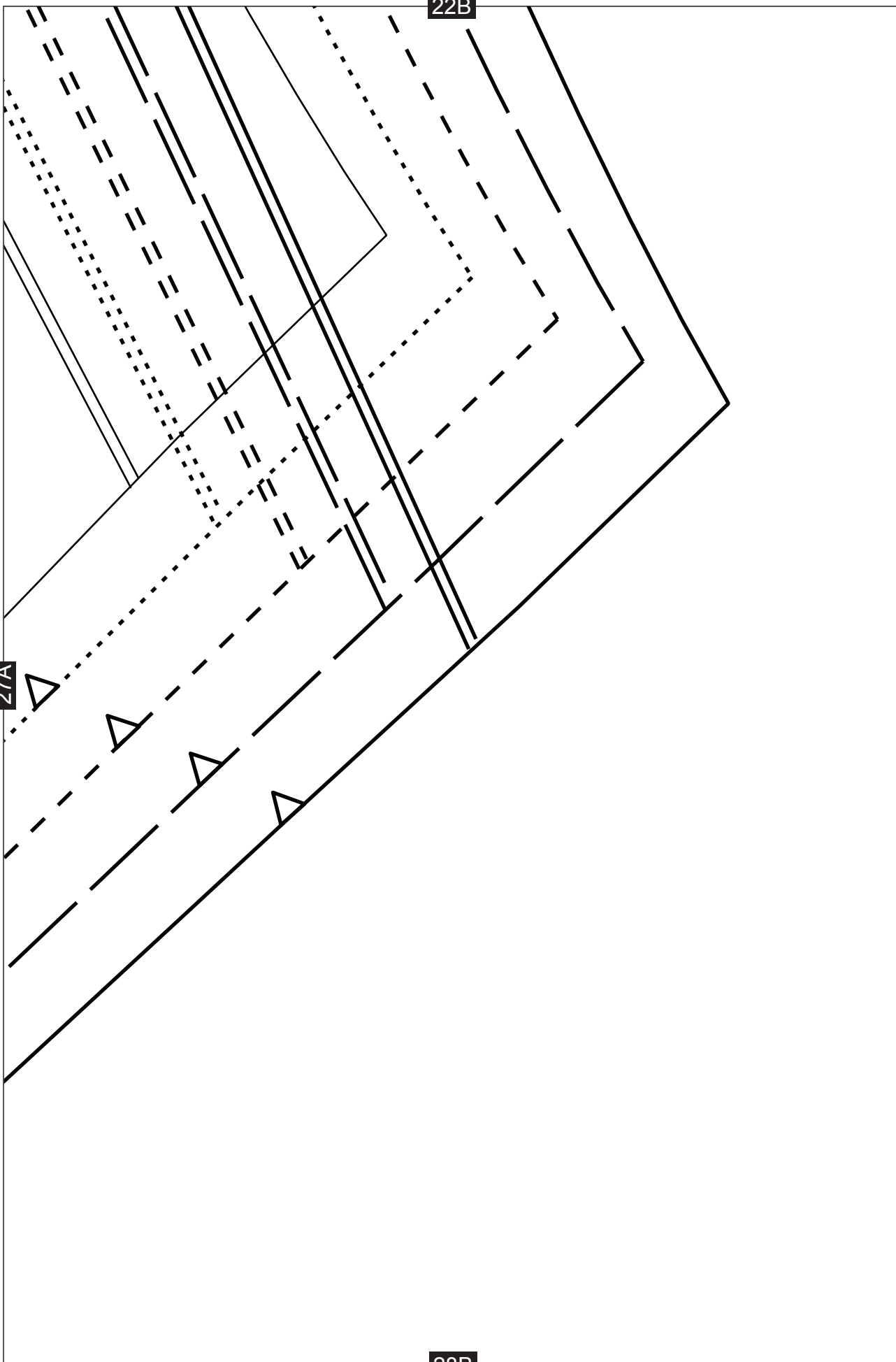

25B

29A

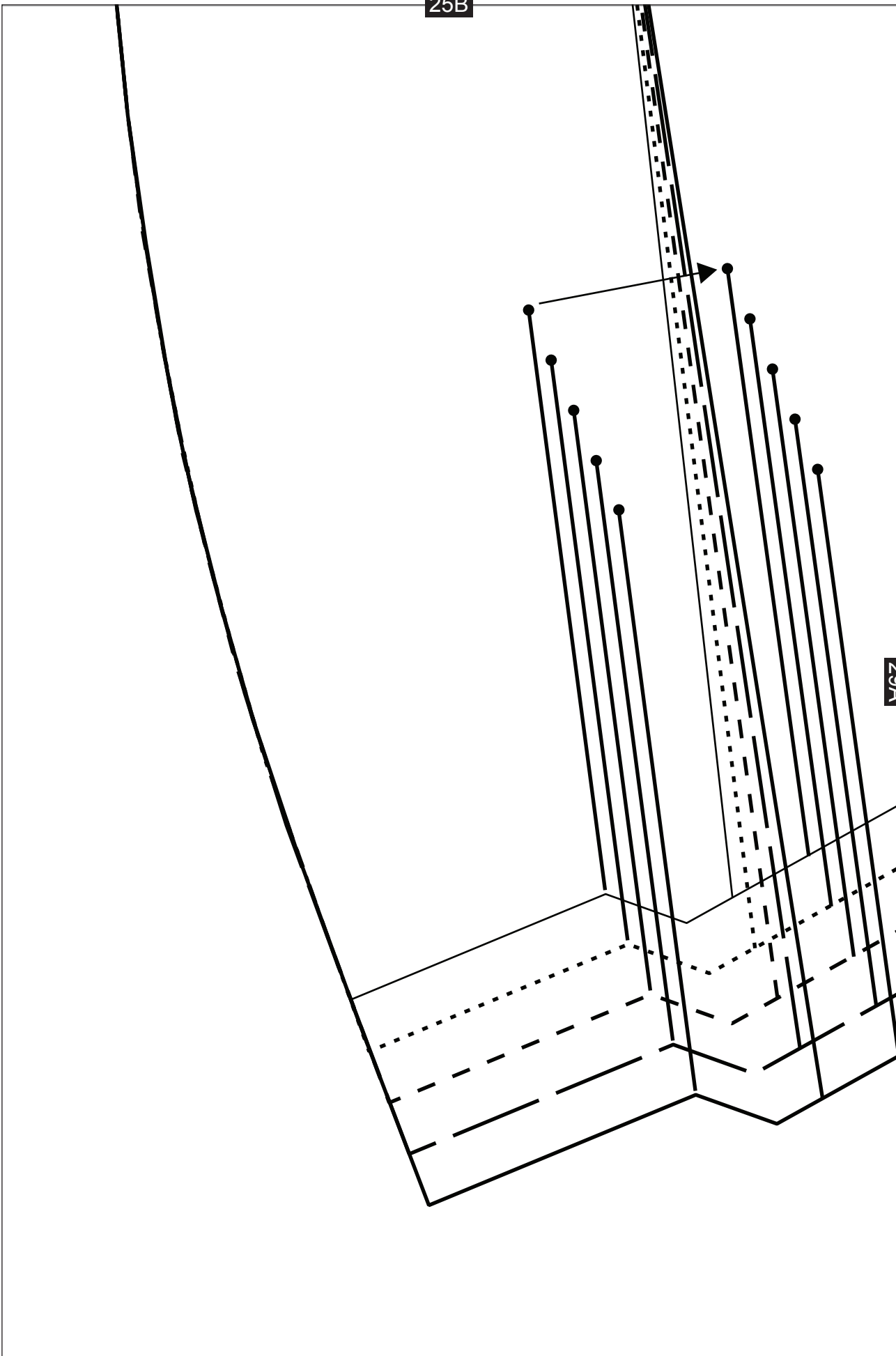

26B

29A

30A

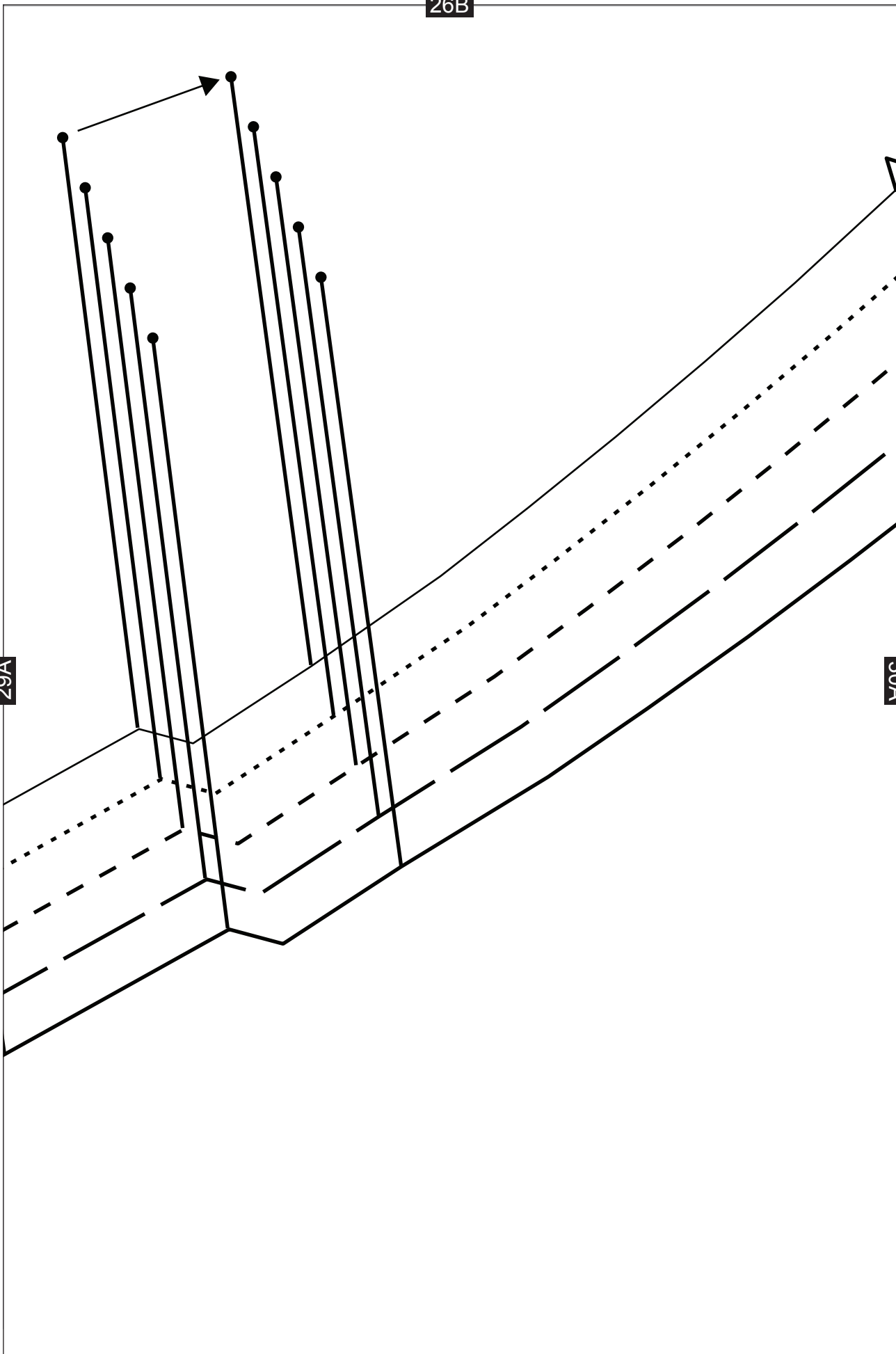

27B

30A

